

# exkal

**e** FOR FUTURE GENERATIONS

**GAMA 0**

## SEMIMURALES GAMA 0 **VELATE**

**GAMA 0** / RANGE 0 / GAMME 0 / SERIE 0

**SIN DESESCARCHES** / NO DEFROST / PAS DE DÉGIVRAGE / KEINE ABTAUUNG

**SOSTENIBLE Y MONOCASCO** / SUSTAINABLE AND MONOBLOCK / DURABLE ET MONOCOQUE / NACHHALTIG UND MONOBLOCK

**+** **VISIÓN PRODUCTO** / PRODUCT VISIBILITY / VISIBILITÉ PRODUITS / PRODUKPRÄSENTATION

**ERGONOMÍA** / ERGONOMY / ERGONOMIE / ERGONOMIE & DREHTÜR

**OPTIMIZACIÓN ESPACIO VENTA** / RETAIL FOOTPRINT OPTIMIZATION / RETAIL FOOTPRINT OPTIMISATION / VERKAUFSFLÄCHENOPTIMIERUNG

**+** **ÁREA TOTAL EXPOSICIÓN** / TOTAL DISPLAY AREA / TDA / TDA



**VELATE**  
SEMIMURALES **REMOTOS**

[exkalsa.com](http://exkalsa.com)

# GAMA 0

SEMIMURALES /  
LOW MULTIDECKS /  
SEMI VERTICAUX /  
SEMI-VERTIKALE

# 3M0

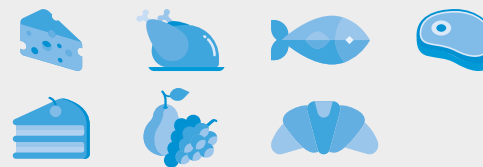

## GAMA 0 / RANGE 0 / GAMME 0 / SERIE 0

mm	2			3			4			5			C		
	TDA	Vol	Suf	TDA	Vol	Suf	TDA	Vol	Suf	TDA	Vol	Suf	TDA	Vol	Suf
	m <sup>2</sup>	l	m <sup>2</sup>	m <sup>2</sup>	l	m <sup>2</sup>	m <sup>2</sup>	l	m <sup>2</sup>	m <sup>2</sup>	l	m <sup>2</sup>	m <sup>2</sup>	l	m <sup>2</sup>
SLHCUO	1,35	463	1,87	2,03	694	2,78	2,7	925	3,74	4,05	1388	5,61	2,46	793	2,63
SLHNUO	1,35	588	2,3	2,03	881	3,44	2,7	1175	4,6	4,05	1763	6,9	2,88	887	2,97
SLHSUO	1,6	600	2,42	2,4	900	3,62	3,2	1200	4,84	4,8	1800	7,26	3,53	1002	3,62
SLHWUO	1,6	738	2,93	2,4	1106	4,39	3,2	1475	5,86	4,8	2213	8,79	3,71	1231	4,42

TDA = Área Total de Exposición / Total Display Area / Zone d'affichage totale / Gesamtausstellungsfläche • Vol = Volumen neto / Net volume / Volume net / Nettovolumen • Suf = Superficie de exposición / Exhibition surface / Surface d'exposition / Ausstellungsfläche.  
**Best energy class model. More information at EPREL or contact our Sales Department.**

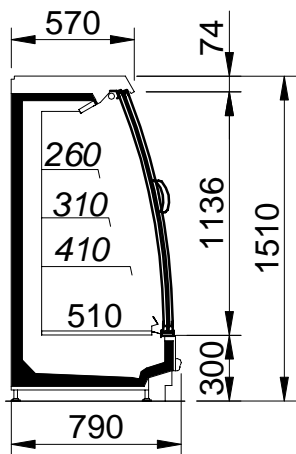

SLHCU-

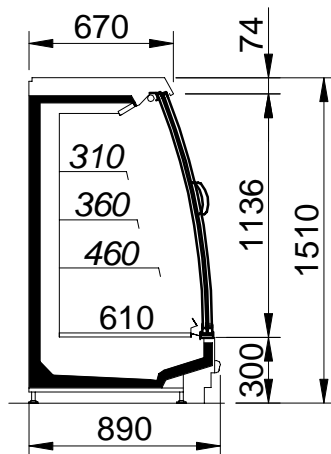

SLHNU-

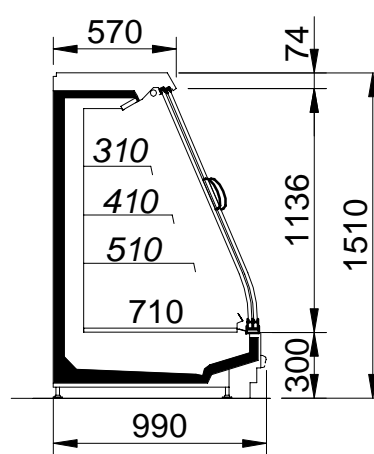

SLHSU-

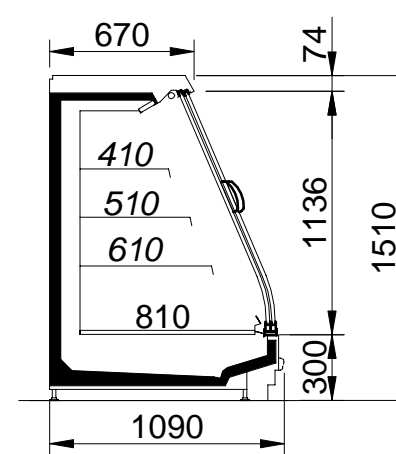

SLHWU-

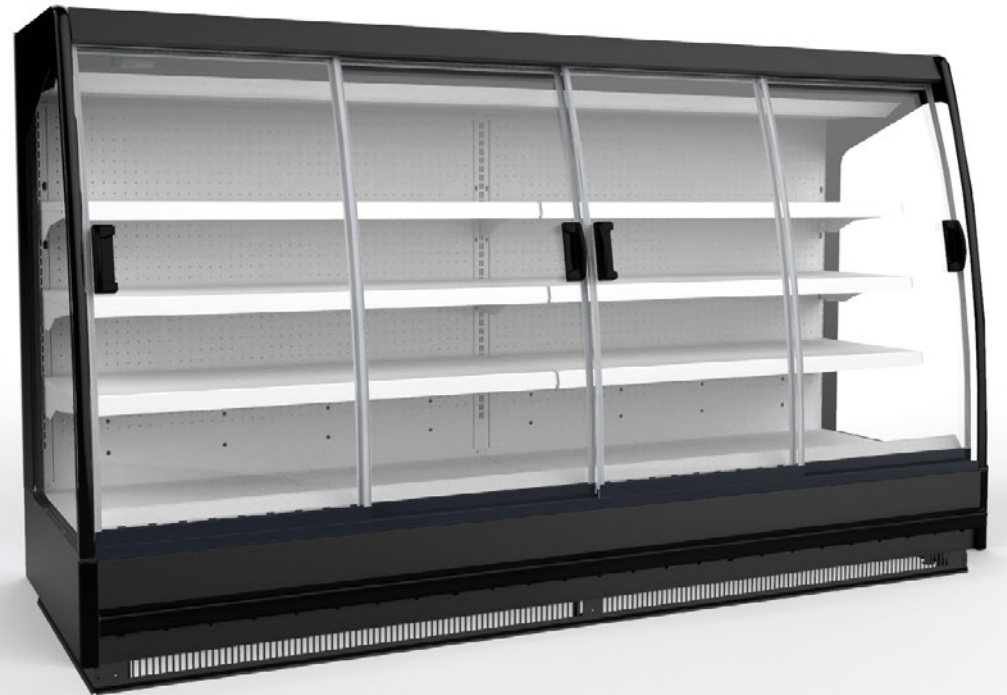
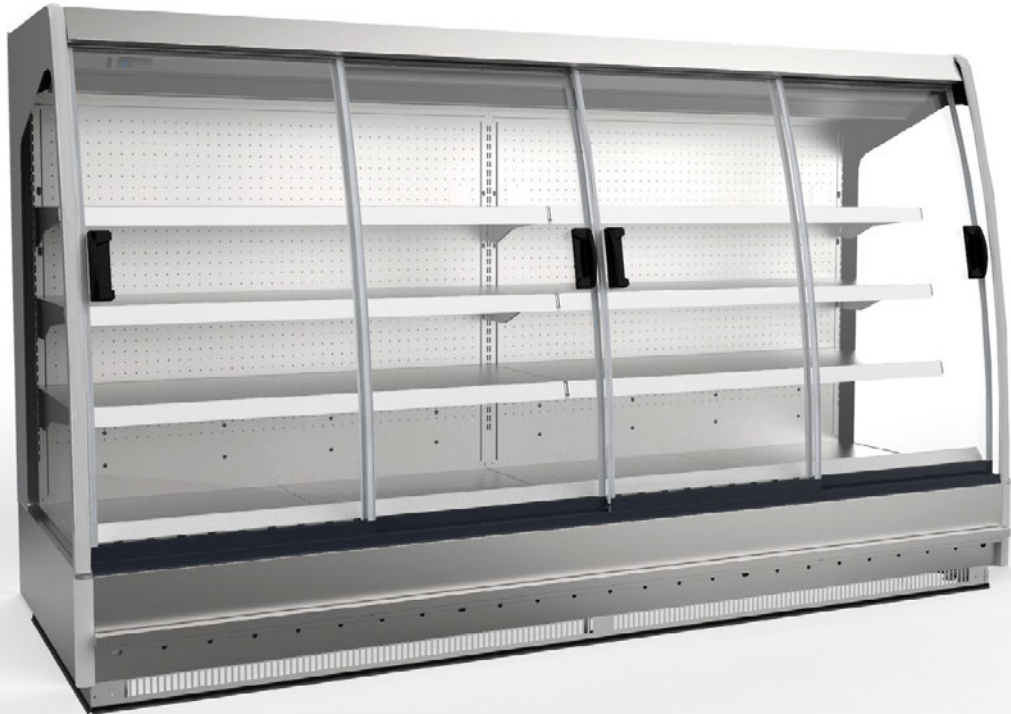

EVAPORATOR

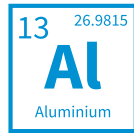
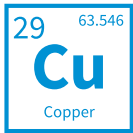
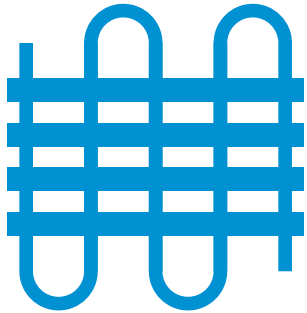

MONOBLOCK



# exkal

FOR FUTURE GENERATIONS

Pol. Ind. El Campillo, C/A N° 1, 31340, Marcilla, Navarra  
(España - Spain)  
+34 948 708 292 | [exkalsa@exkalsa.com](mailto:exkalsa@exkalsa.com) | [exkalsa.com](http://exkalsa.com)

**exkal**  
CONCEPT

[exkalconcept.com](http://exkalconcept.com)

**horexkal**



[horexkal.com](http://horexkal.com)

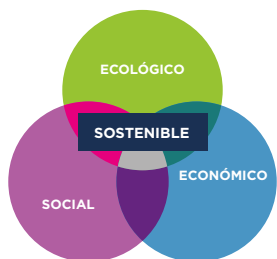

SR-0009-ES



SI-0011/2021



ER-0149/2011



SST-0022/2011



GA-2011/0074

